

CR7 WITH 500S SMART ANTENNA KIT

CR7 WITH 500S KIT
117-2295-001*

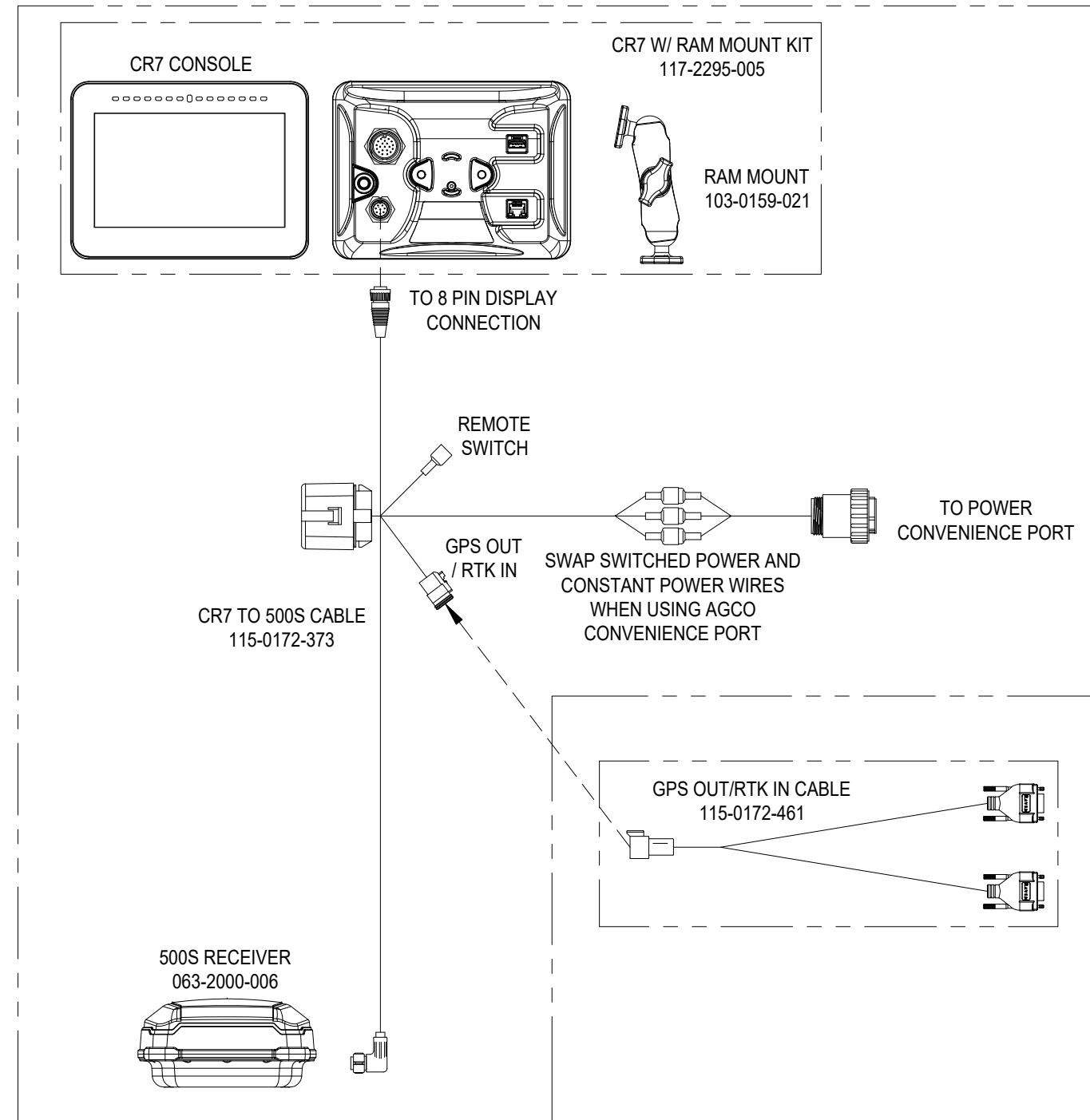

NOTE: ISOBUS CABLING CAN BE ADDED BY CONNECTING TO 20 PIN DISPLAY CONNECTION AND LEAVING 8 PIN DISPLAY CONNECTION AS SHOWN.

* KIT SUFFIXES:

UN: UNIVERSAL TERMINAL UNLOCK

TN: UT & TASK CONTROLLER (TC) UNLOCK

TS: UT, TC & SINGLE PRODUCT VRA UNLOCK

TC: UT, TC & MULTI-PRODUCT VRA UNLOCK

RELEASED DATE	ECO #	REV.	DRAWING NO.
5/14/18	31390	B	054-2295-001
8/19/19	33092	C	054-2295-001

CR7 - SMARTRAX/ACCUBOOM ONLY - GEN II (BASIC KIT EXPANSION)

4

3

2

1

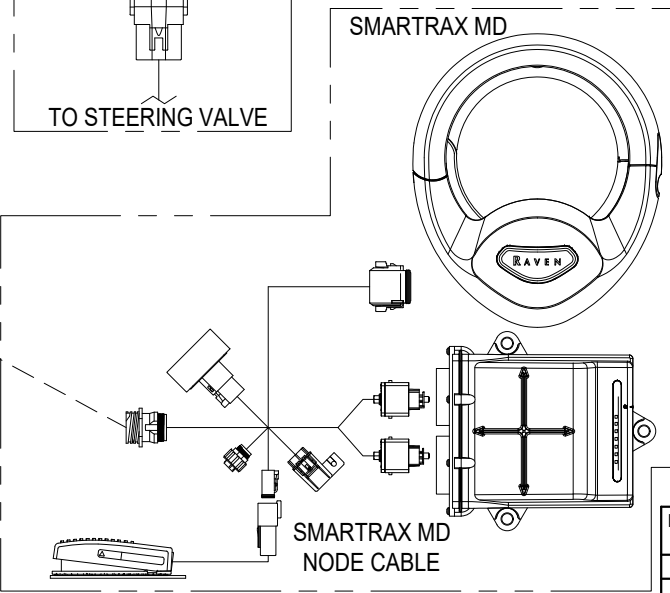
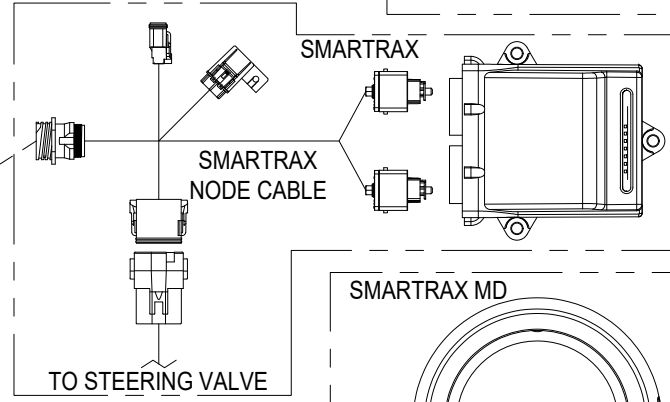
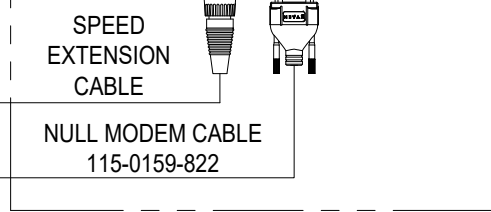
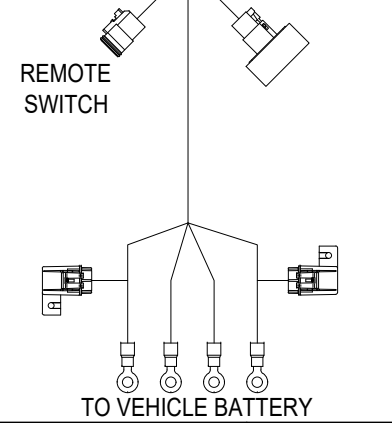
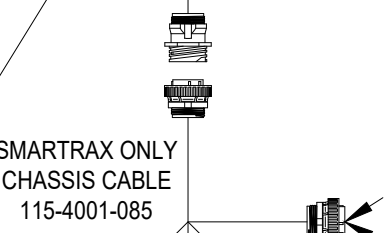
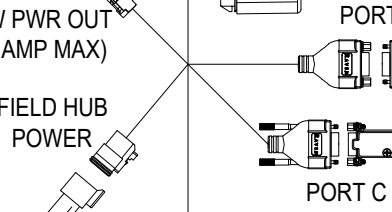
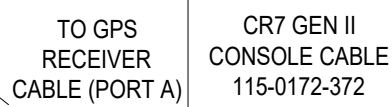
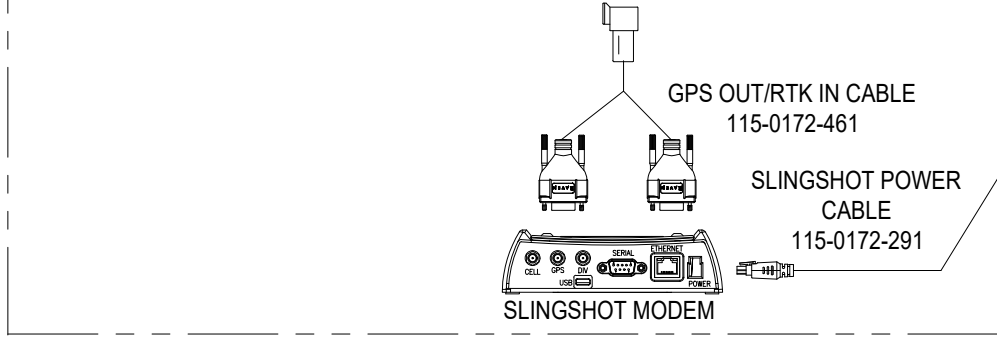
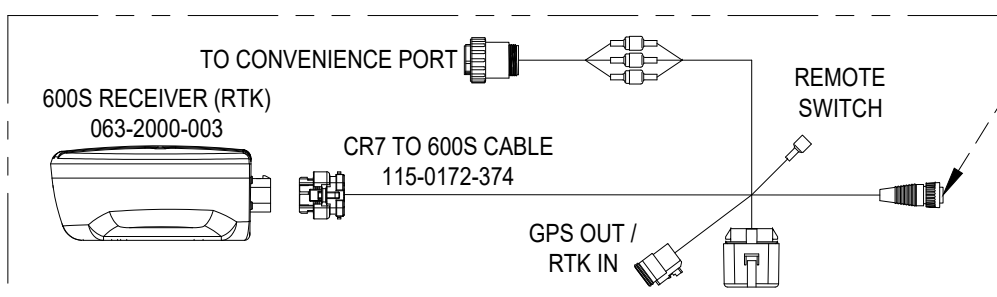
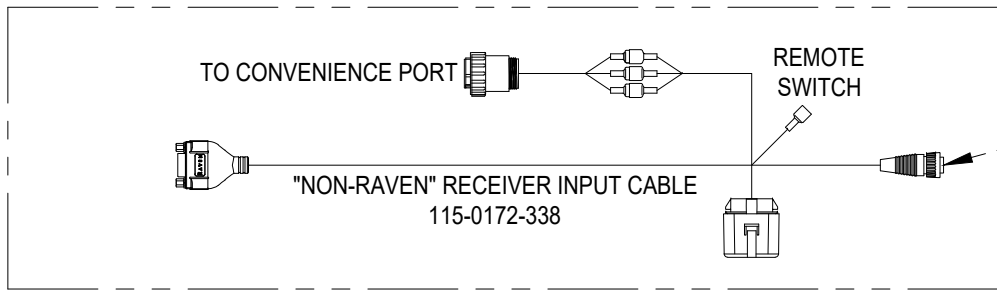
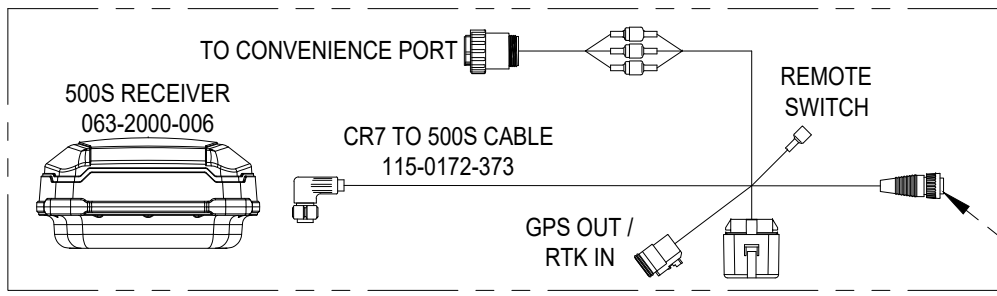
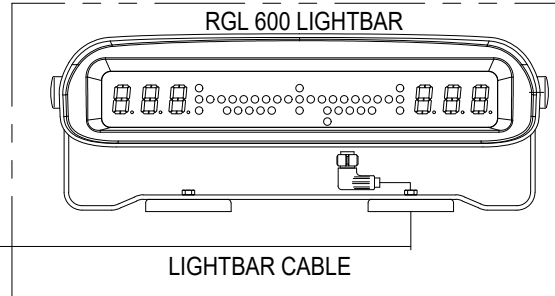
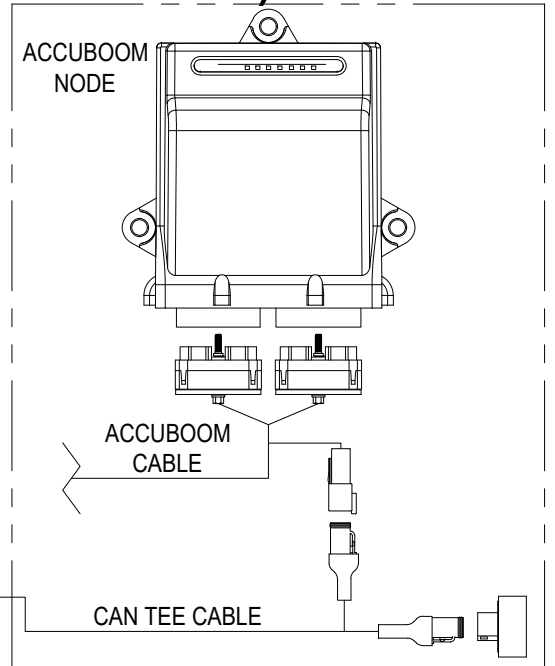
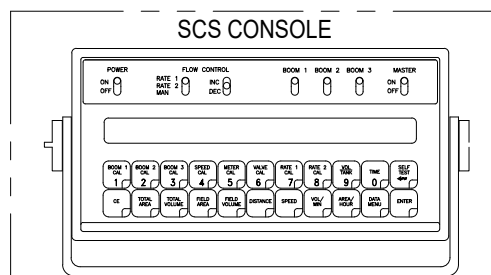
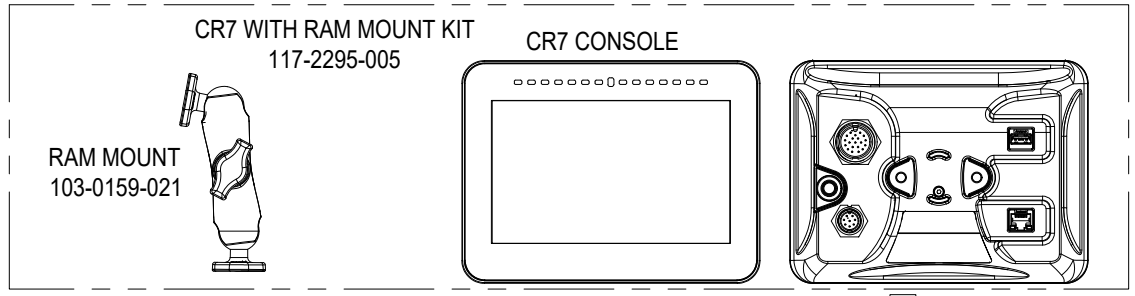

B

B

A

A

4

3

2

1

RELEASED DATE	ECO #	REV.	DRAWING NO.
5/14/18	31390	B	054-2295-001
8/19/19	33092	C	054-2295-001

CR7 - SMARTRAX (GEN 3 OR IBCB CABLING) (BASIC KIT EXPANSION)

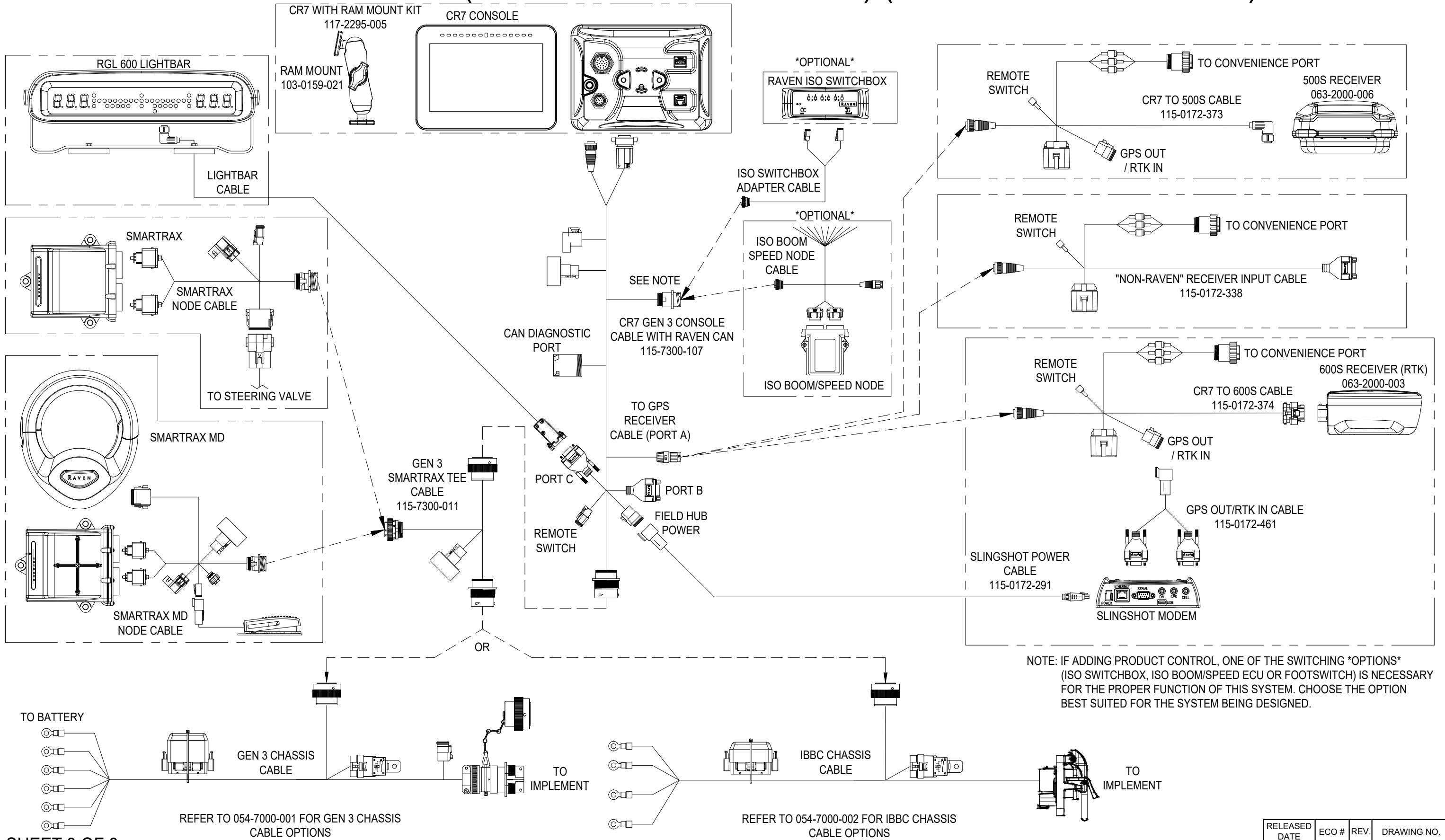

NOTE: IF ADDING PRODUCT CONTROL, ONE OF THE SWITCHING *OPTIONS* (ISO SWITCHBOX, ISO BOOM/SPEED ECU OR FOOTSWITCH) IS NECESSARY FOR THE PROPER FUNCTION OF THIS SYSTEM. CHOOSE THE OPTION BEST SUITED FOR THE SYSTEM BEING DESIGNED.

REFER TO 054-7000-001 FOR GEN 3 CHASSIS CABLE OPTIONS

REFER TO 054-7000-002 FOR IBCB CHASSIS CABLE OPTIONS

RELEASED DATE	ECO #	REV.	DRAWING NO.
5/14/18	31390	B	054-2295-001
8/19/19	33092	C	054-2295-001

CR7 - RS1/ISO PRODUCT CONTROL (GEN 3 OR IBBC CABLING)

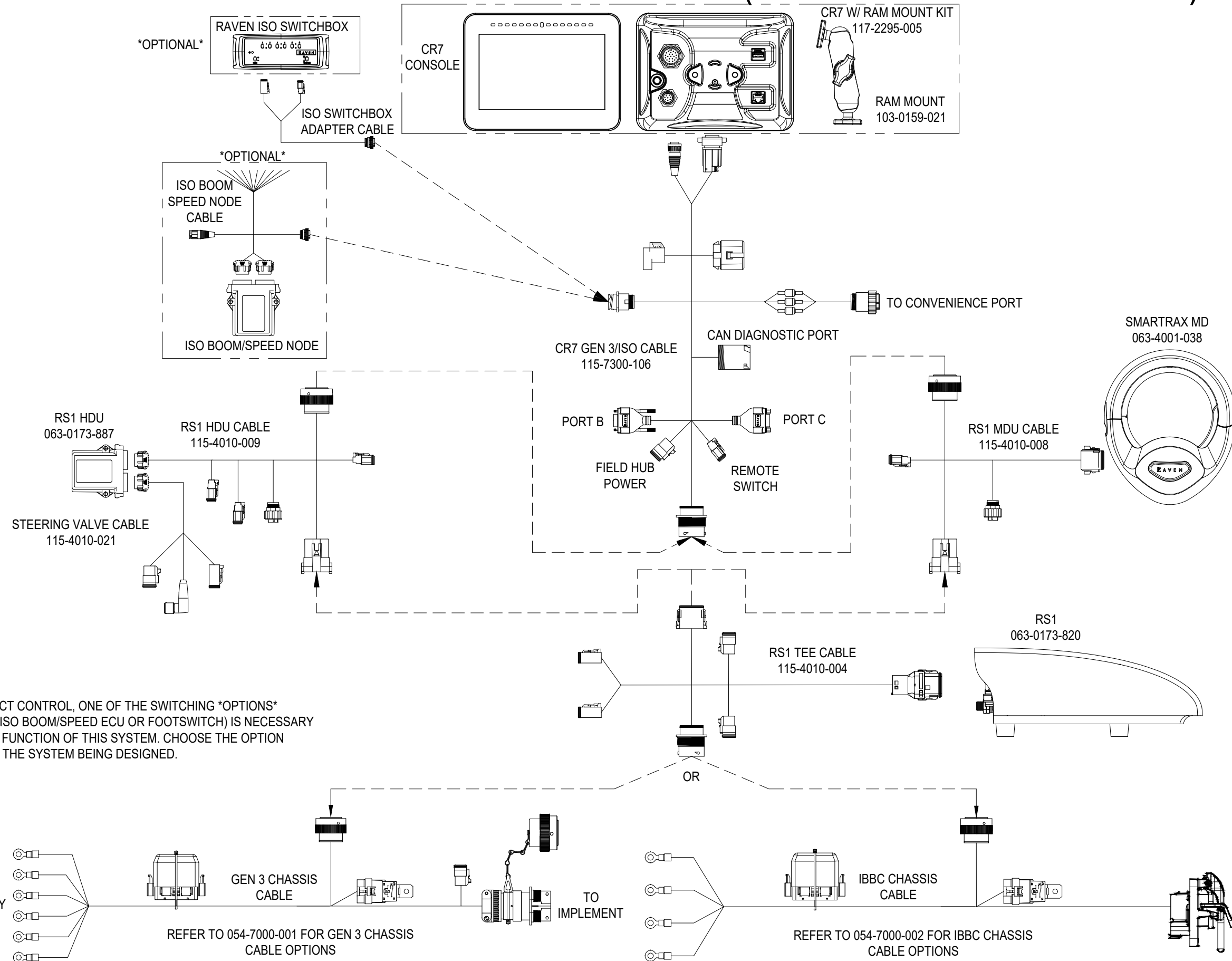

NOTE: IF ADDING PRODUCT CONTROL, ONE OF THE SWITCHING *OPTIONS* (ISO SWITCHBOX, ISO BOOM/SPEED ECU OR FOOTSWITCH) IS NECESSARY FOR THE PROPER FUNCTION OF THIS SYSTEM. CHOOSE THE OPTION BEST SUITED FOR THE SYSTEM BEING DESIGNED.

RELEASED DATE	ECO #	REV.	DRAWING NO.
5/14/18	31390	B	054-2295-001
8/19/19	33092	C	054-2295-001

CR7 EXPANSION TO SCS CONSOLE AND ACCUBOOM

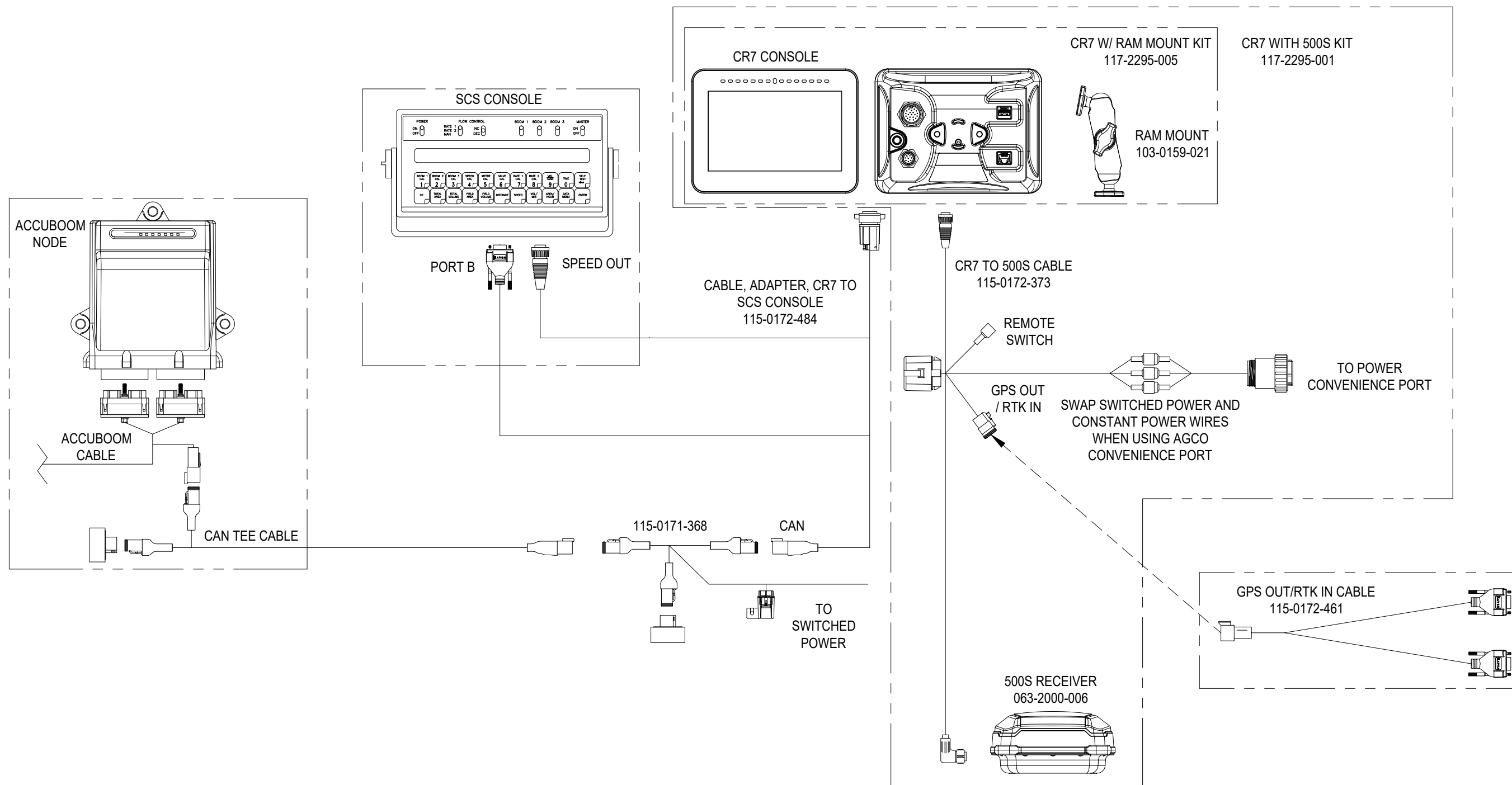

RELEASED DATE	ECO #	REV.	DRAWING NO.
5/14/18	31390	B	054-2295-001
8/19/19	33092	C	054-2295-001

4

3

2

1

CR7 WITH RS1/HDU

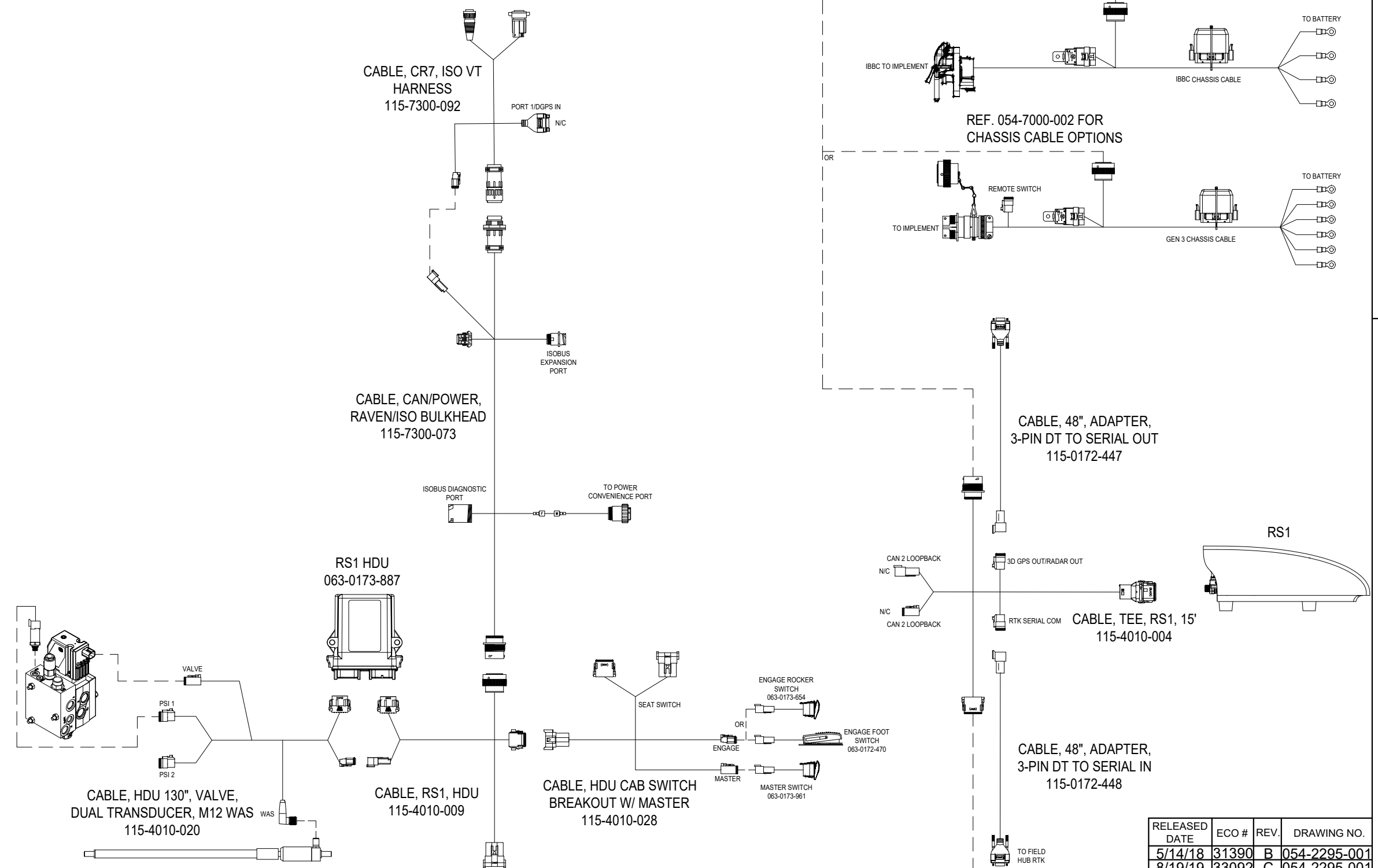
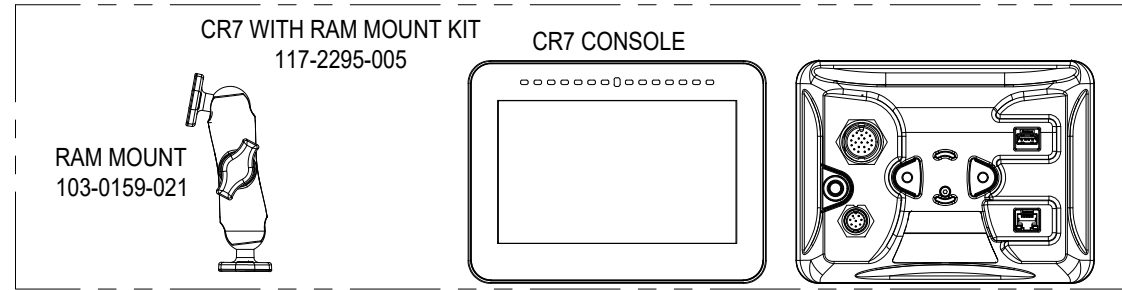

B

B

A

A

RELEASED DATE	ECO #	REV.	DRAWING NO.
5/14/18	31390	B	054-2295-001
8/19/19	33092	C	054-2295-001

4

3

2

1

4

3

2

1

CR7 ISOBUS AUXILIARY DISPLAY

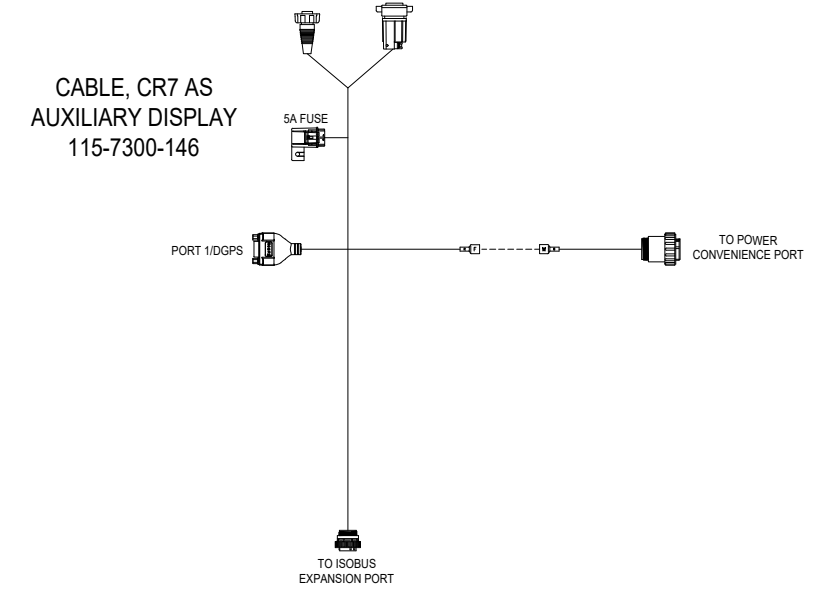
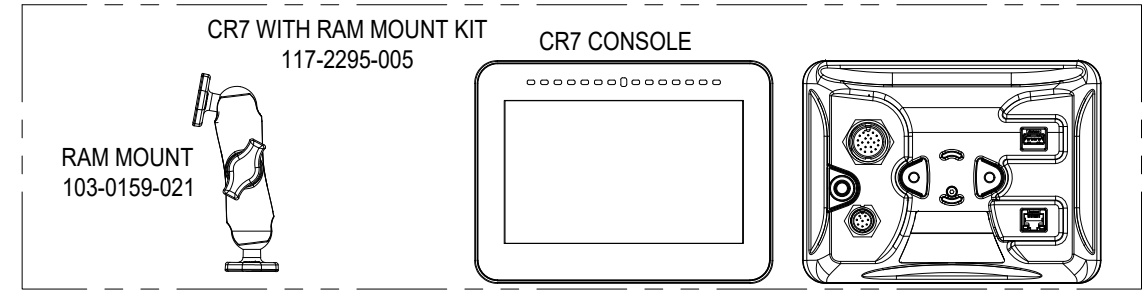

B

B

A

A

RELEASED DATE	ECO #	REV.	DRAWING NO.
5/14/18	31390	B	054-2295-001
8/19/19	33092	C	054-2295-001

4

3

2

1

4

3

2

1

CR7 - BASIC TRACTOR INSTALL WITH IBBC

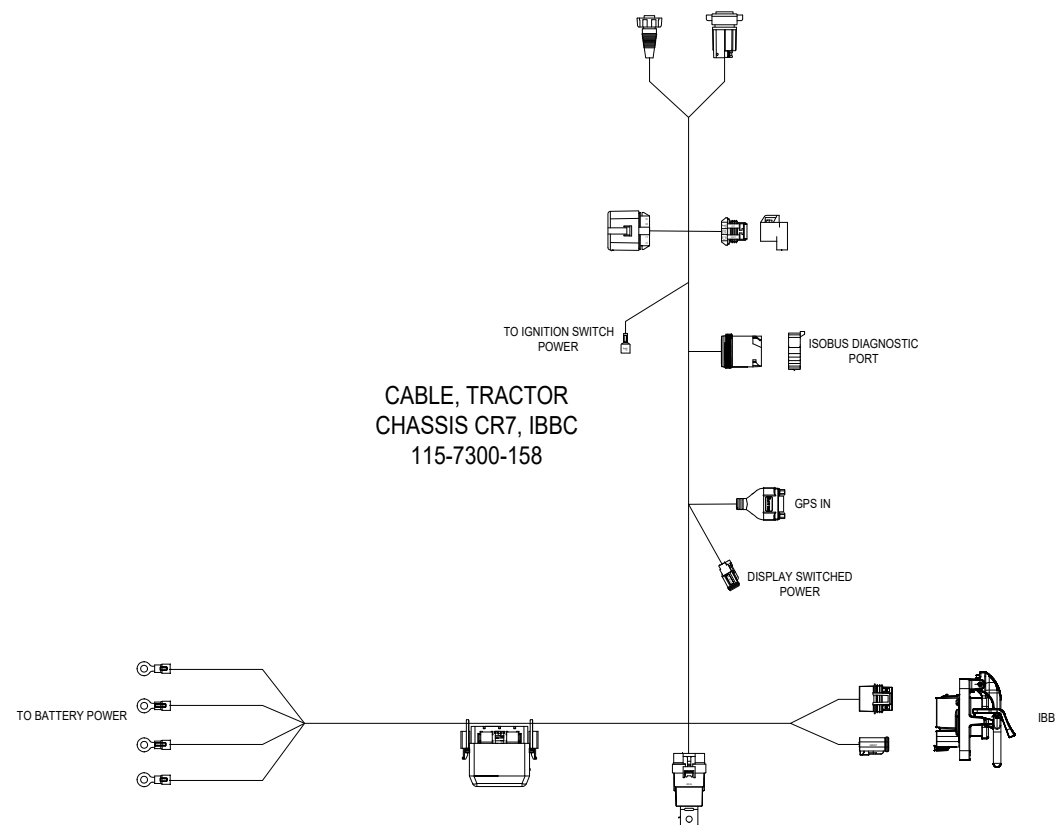
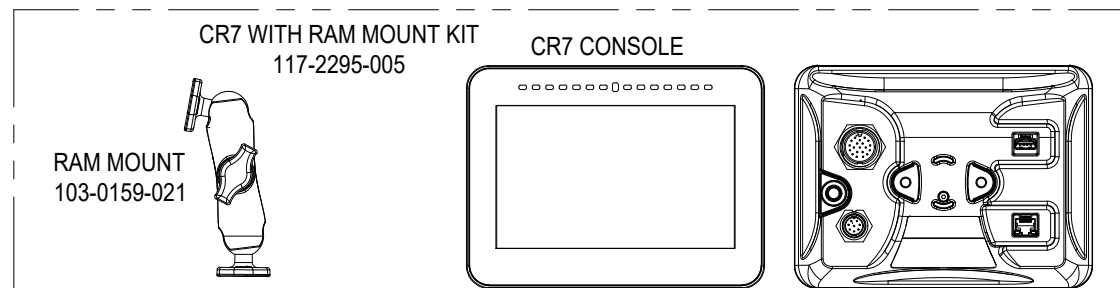

RELEASED DATE	ECO #	REV.	DRAWING NO.
5/14/18	31390	B	054-2295-001
8/19/19	33092	C	054-2295-001

4

3

2

1